



XC10 Extinguishing control panels

Market package 2.1

- **Advanced control panels for detection and alarming as well as for the activation of the extinguishing process**
 - Microprocessor-controlled fire detection and extinguishing control panel
 - Standard version for small to medium single sector extinguishing application
 - Comfort version for medium to large single sector extinguishing application
 - 19" rack panel for multi-sectors extinguishing applications, up to 16 flooding zones
 - Easily connectable to a larger fire detection system
 - Free control logic
- **Enhanced features with highest safety standard**
 - Easy on-site configuration
 - Upload / download of configuration data's
 - Event logging facilitates identifying origin of events
 - Display countdown timer before extinguishing release (with comfort version)
 - Extinguishing automatic activation with various alarm combinations
 - Optional multi-sector module (with rack version)
 - 72h battery backup time (with comfort version)
 - Various system test modes
 - Automatic calibration facility for actuators control lines (solenoid or pyrotechnical actuators)
 - In compliance with EN12094-1 / EN54-2 +A1 / EN54-4 +A2

XC10 are reliable and efficient panels for detection and extinguishing control. The portfolio offers panels for both single- and multi-sector applications. The user interface provides a clear layout, so users can gain a complete system overview at a glance. XC10 can be connected to a wide range of conventional and collective fire detectors as well as with most types of extinguishing systems such as systems based on natural and chemical agents and water-combined systems.

Whether independent or integrated, the XC10 panel family can protect either a single-sector or a multi-sector application. This makes XC10 the ideal choice for applications ranging from IT rooms, data centers, generators, transformers, turbines, control rooms, clean rooms, cable ducts, storage rooms to libraries, archives and museums, etc. With up to 16 flooding zones, XC10 is the ideal choice for large applications with several extinguishing sectors. Another advantage: only one extinguishing cylinder battery is needed to protect several sectors.

XC10 can also be easily integrated into larger fire safety systems. Such integration means that XC10 can be connected with powerful control panels. This ensures comfortable visibility of both fire detection and extinguishing at a central point. As a further benefit, the fire safety system can be connected to a Siemens danger management system.

General functional principle

An extinguishing system consists of the following components:

- Control unit for evaluating, displaying and operating all functions of an extinguishing area
- Fire detectors for automatic activation of extinguishing
- Manual Release button for manual activation of extinguishing
- Emergency hold button to temporary stop the extinguishing or abort button to cancel the initiated extinguishing release as long as the pre-warning time is running
- Mechanical blocking to disable completely the extinguishing
- Alarm horn and illuminated warning panel for on-site alarm notification
- Remote transmission facility for transmitting alarms and faults
- Control device for closing doors and fire protection flaps and shutting down of ventilation
- Releasing elements for triggering the valves for activation of extinguishing
- Devices to report the flooding and the loss of extinguishing agent

Control panel

The XC10 extinguishing control unit is used for displaying, operating and monitoring the functions of an extinguishing area and its immediate environs. All detectors, alarm horn, illuminated warning panel, monitoring devices and controllers are connected to the extinguishing control unit. If a detector triggers an alarm, it is transmitted to the extinguishing control unit. At the extinguishing control unit the decision is made how the alarm is to be processed. The same applies to faults. The processing of alarms and faults is different depending on the configuration of the system.

The extinguishing control unit is connected to the power mains at all times. In the event of a mains power failure the extinguishing control unit is supplied by built-in batteries. Battery operation in the event of a mains power failure is for a limited time.

Fire Detector

Up to 32 fire detectors are consolidated into a detector zone. In the event of fire, the detector zone of the alarming fire detector is indicated on the extinguishing control unit. In the basic settings, detector zones 1 and 2 serve the automatic activation of extinguishing. The extinguishing control unit assesses the zones in a so-called cross-zoning: in order to activate extinguishing, one fire detector from each group must trigger an alarm. This principle ensures high reliability so that extinguishing is not unjustified triggered.

Manual Release Button

Extinguishing can be manually activated by using a Manual Release button.

Remote Transmission

Along with on-site alarm notification, activation of extinguishing and faults can be transmitted via a remote transmission device to an external receiving station or passed on to a fire detection system.

Fire Protection Installations

As a rule, before automatic extinguishing is triggered, building fire protection installations must be set in the correct position. For example: door holding magnets are de-energized, fire protection flaps are closed and fans and air-conditioning systems are turned off.

Activation of Extinguishing and Monitoring





Valves on the extinguishing agent cylinders are triggered for activation of extinguishing. The effected activation of extinguishing is reported to the control unit via a pressure switch located at the cylinder bank. In addition, the weight or the pressure of the extinguishing agent cylinders are constantly checked using cylinder scales or manometers that trigger a contact if the value is too low.

Extinguishing Blocking

During the pre-warning time an activation of extinguishing already initiated can be temporarily stopped by pressing the Emergency Hold Button or canceled by pressing the Emergency Abort Button. The automatic activation of extinguishing can be blocked as a precaution for maintenance work. In this instance, in the event of fire, it is possible to press the Manual Release Button for activation of extinguishing

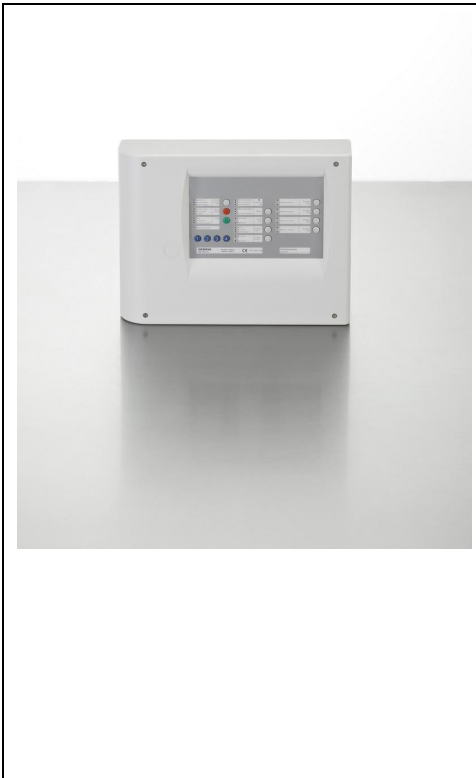
Mechanical Blocking Device

The mechanical blocking device is used for blocking the activation of extinguishing during maintenance work. As a rule it is used in CO₂-extinguishing systems and cannot be influenced by the extinguishing control unit. The mechanical blocking device can be set to "closed" or "open" mostly by turning a lever. Not opened position is shown on the extinguishing control unit.

	<p>XC1001-A Standard variant</p> <p>The compact dimensions of XC1001-A are ideally adapted for single-sector applications, small to medium installations. It provides a full range of monitored inputs and outputs as well as digital and relays outputs.</p> <ul style="list-style-type: none"> - 2 monitored control lines for actuators (solenoid or pyrotechnical) - 3 monitored control lines for sounders, optical warning panels or remote transmission - 8 configurable digital outputs - 5 configurable relay outputs which can be used to transmit information's to an FS20/FC720 fire detection panel via FDnet/C-NET I/O modules - 3 collective detection lines - 1 monitored input for electrical manual triggering - 4 configurable control inputs - Maximum 12h backup time with battery capacity of 4,5 A/h - Up to 512 events – such as alarms, releases, faults, disablements and tests, acknowledgements or resets – can be logged in an event memory - Configuration settings can be downloaded in a PC and printed - Easy and fast commissioning using 4 digit display - 105W power supply / 3.5 A
	<p>XC1005-A Comfort variant</p> <p>This variant offers the same functions and connection possibilities than XC1001-A. Thanks to the robustness of the cabinet, this variant is an ideal choice for medium size single-sector installations.</p> <ul style="list-style-type: none"> - Large and robust cabinet - Maximum 72h backup time with battery capacity of 17 A/h - More space inside the cabinet for optional interfaces or modules - Display countdown timer before extinguishing release
	<p>XC1003-A 19" rack variant</p> <p>This variant offers the same connection possibilities than XC1001-A. Up to 16 panels can be installed in a 19" housing and configured to control a complex multi-sector installation.</p> <ul style="list-style-type: none"> - Thanks to the optional multi-sector modules, up to 16 panels can be connected together - A common control cylinder can be activated - Selector valves can be controlled and their position can be monitored - Inter-blocking functions can be configured
	<p>XT1001 / XT1002</p> <p>Additional repeater terminals can be connected to the XC10 control panel for quick access to system information and immediate operation.</p> <ul style="list-style-type: none"> - Up to 16 remote terminals can be used at the same time - Monitored line - 2 variants whether the application needs only display of information's or control of the XC10

Typical extinguishing single sector installations

XC10 - single-sector Independent scenario

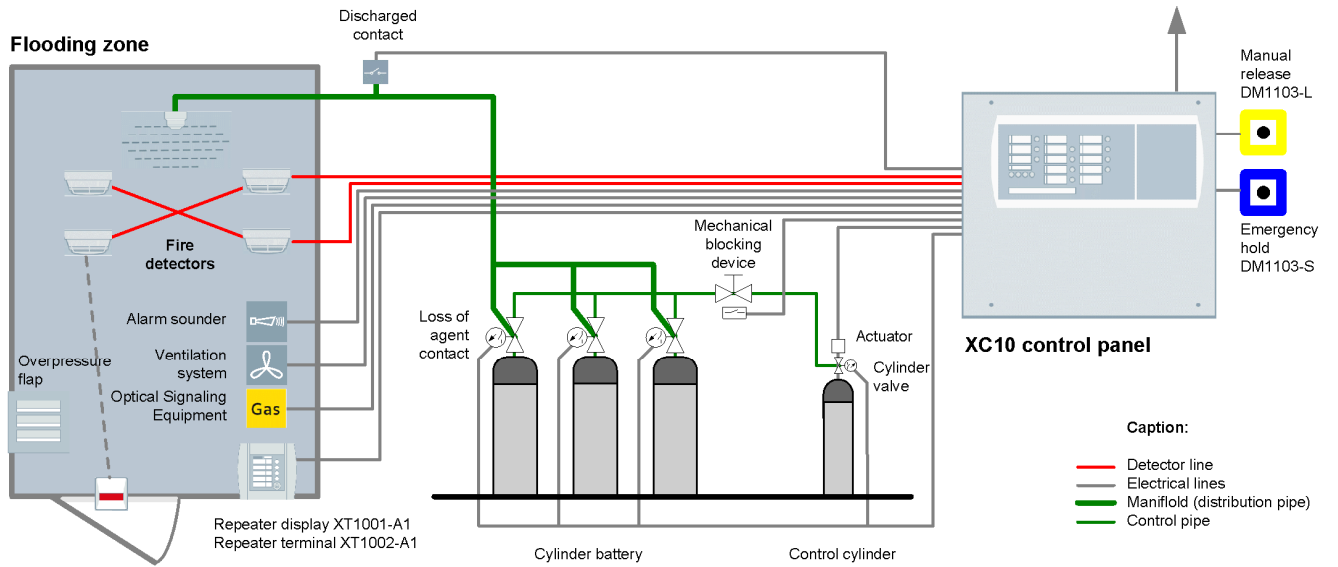

XC10 - single-sector Integrated scenario

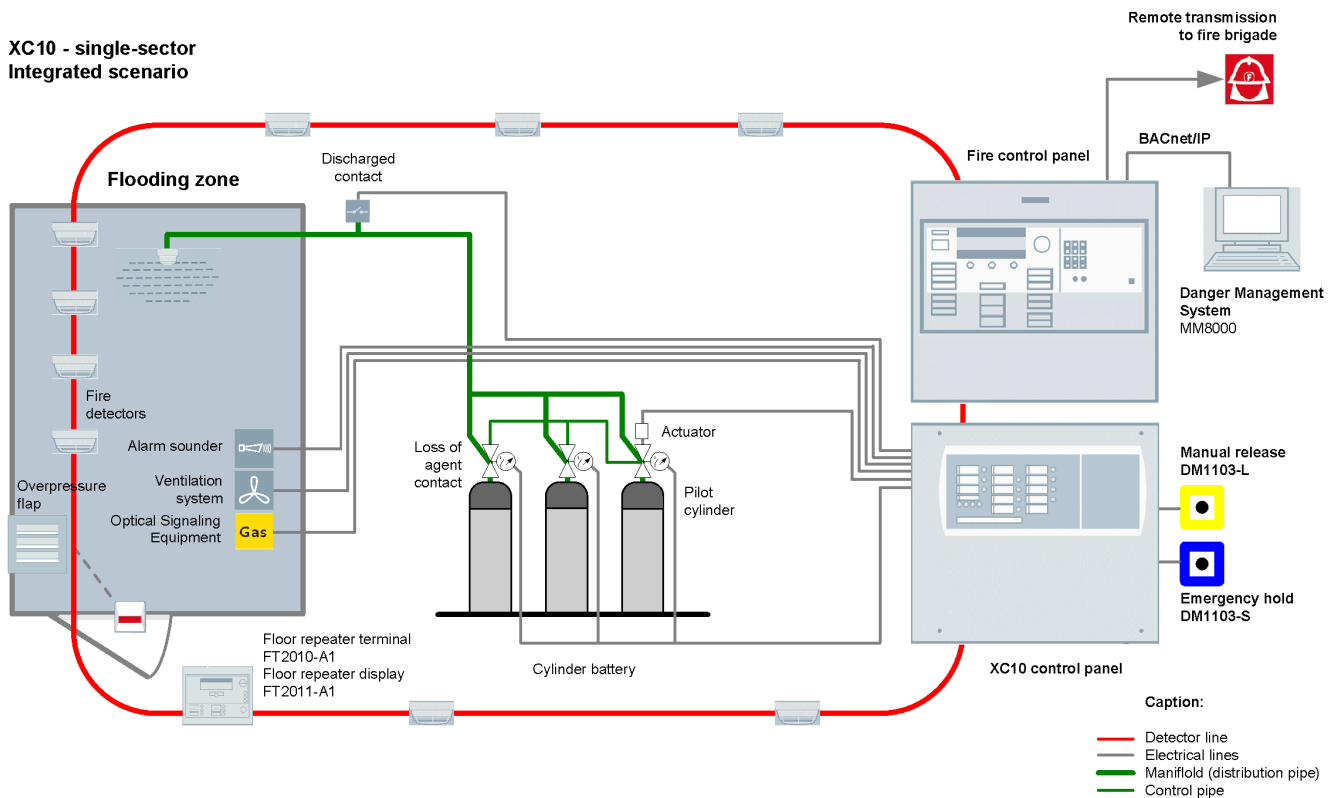

Typical extinguishing multi-sector installation

XC10 - multi-sector Fire safety system integrated scenario

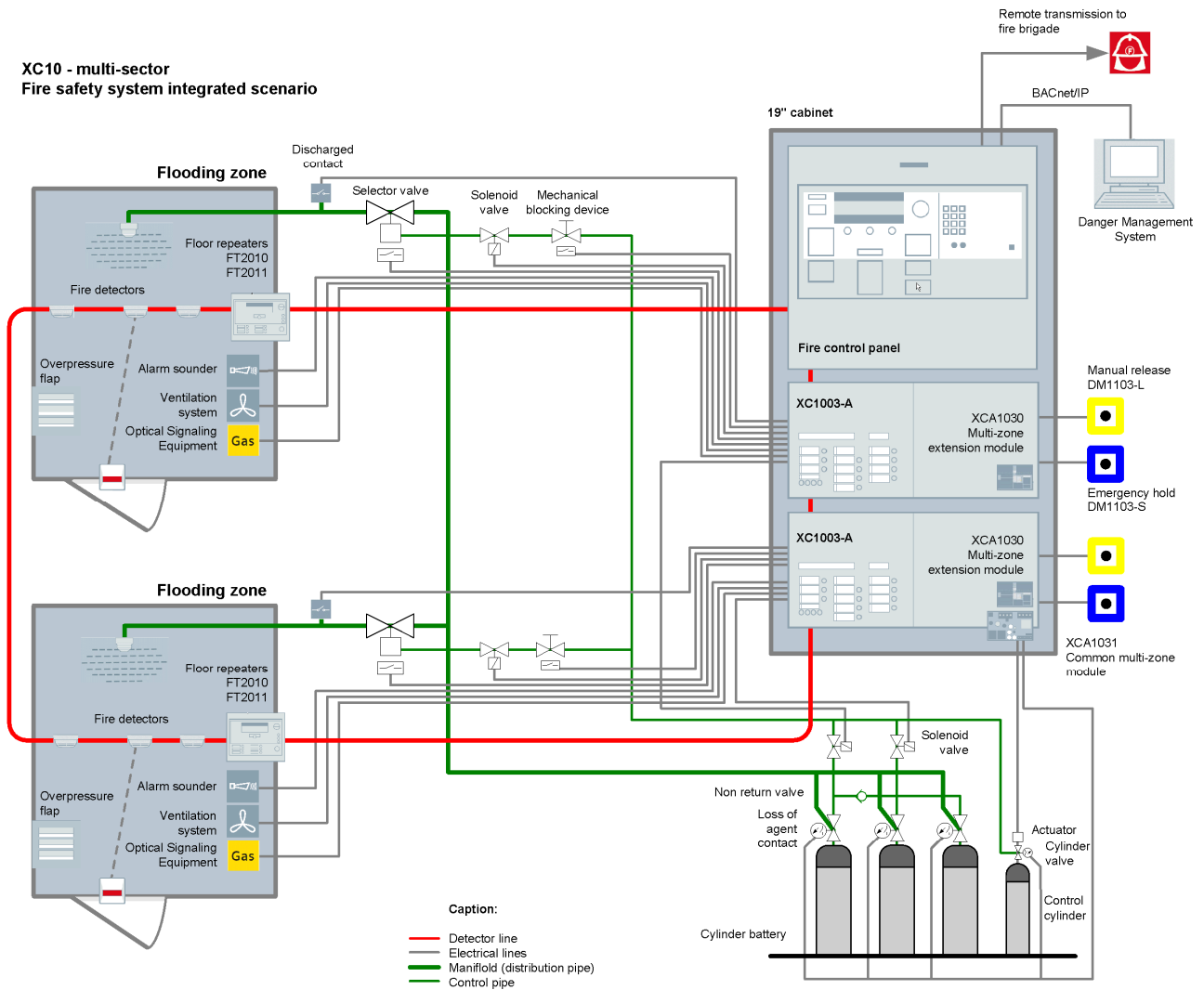

Technical specifications

Power supply (FCP1004-E)	Primary source (mains)	
	Voltage	115 / 230 VCA +10 ...-15% – 50 / 60 Hz
	Current	1.75 A max.
	Power	150 VA max.
	Secondary source (batteries)	
	Connectable batteries	2 x 12 V / 4.5 ... 17 Ah
	Voltage	23.4 ... 27.6 V
	Charging current max.	1.3 A (with temperature compensation)
	Internal resistance max.	1 Ω
	Deep discharge (disconnection threshold)	20 V +/-3%
	Output	
	Voltage	27.3 V +/- 0.3 V (25°C)
	Max. available current	Imax a : 2 A (batteries loading) Imax b : 3.5 A (batteries loaded)
	Min. current	0.05 A
	Power	105 W max.
	Switching frequency / Ripple	132kHz / 70 mVpp max.
Main board (XCM1002)	Input voltage	22.5 ... 27.6 V (25°C)
	Current consumption	190 mA max. without primary source
	I/Os security level	SELV (Safety Extra Low Voltage)
Detection lines	Type / number of detectors	Collective / 32 max. (according to detector type)
	Compatible detectors	Siemens (Algorex, Cerberus-PRO, Sinteso, Synova)
	End of line element (EOL)	Transzorb 18 V (P6KE18CA)
	Line resistance	80 Ω max.
Manual release line	Type / number of manual actuators	DM1103-L / 32 max.
	End of line element (EOL)	Transzorb 18 V (P6KE18CA)
	Line resistance	80 Ω max.
Monitored inputs	4	
	Activation resistance	680 Ω or 1.2 kΩ
	End of line element (EOL)	3.3 kΩ resistance
	Line resistance	80 Ω max.
Control inputs (non monitored)	4	Activation +24 V, via contact
Monitored control outputs	Outputs 1 to 3	
	Control voltage / current	24 V / 1 A max.
	End of line element	3.3 kΩ resistance
	Outputs 4 and 5	
	Control voltage / current	24 V / 2 A max.
	End of line element	No EOL (line calibration)
Driver outputs	8 (programmable)	24 V / 40 mA max.
Relay outputs (contacts)	5 (4 programmable)	30 V / 1 A max. / NO or NC
Connections	XCM1002	
	Inputs - outputs type / section	Plug-in screw terminal blocks 2.5 mm ² max. (X5, X5, X7) 1.5 mm ² max. (all others)
	FCP1004-E	
	mains input type / section	Plug-in screw terminal block / 2.5 mm ² max
Environmental conditions	Operating / Storage temperature	-5 ... +40° C / -20 ... +60° C
	Humidity relative at 40 ± 2° C	93% max., without condensation
Mechanical data	XC1001-A	
	Cabinet / Protection index	Metal frame with plastic cover / IP30
	Color	RAL9003 (cover), RAL9006 (user interface)
	Dimensions (l x h x p) / Weight	370 x 286 x 90 mm / 4.1 kg
	XC1005-A	
	Cabinet / Protection index	Metal case with plastic cover / IP40
	Color	RAL9003 (cover), RAL9006 (user interface)
	Dimensions (l x h x p) / Weight	505 / 375 / 125 mm / 6.5 kg
	XC1003-A	
	Cabinet / Protection index	Rack 19" 4U / IP30
	Color	RAL9006
	Dimensions (l x h x p) / Weight	482.6 (19") x 177.8 (4U) x 187 mm / 6.6 kg
Conformity	EN 12094-1, EN 54-2/A1, EN 54-4/A2	—

09  1116	XC1001-A	Siemens Switzerland Ltd; Gubelstrasse 22 CH-6301 Zug
		Technical data: see doc. 008399
XC1001-A - Electrical extinguishing control device with integrated fire detection and alarm function, incl. FCP1004-E Power supply equipment for use in fire detection and fire alarm systems installed in buildings.		
305/2011/EU (CPR): EN 12094-1 / EN 54-2 / EN 54-4 ; 2014/30/EU (EMC): EN 50130-4 / EN 61000-6-3 ; 2014/35/EU (LVD): EN 60950-1 ; 2011/65/EU (RoHS): EN 50581		
The declared performance and conformity can be seen in the Declaration of Performance (DoP) and the EU Declaration of Conformity (DoC), which is obtainable via the Customer Support Center: Tel. +49 89 9221-8000 or http://siemens.com/bt/download		
DoP No.: 1116-CPD-043 ; DoC No.: CED-XC1001-A		

09  1116	XC1003-A	Siemens Switzerland Ltd; Gubelstrasse 22 CH-6301 Zug
		Technical data: see doc. 008399
XC1003-A - Electrical extinguishing control device with integrated fire detection and alarm function, incl. FCP1004-E Power supply equipment for use in fire detection and fire alarm systems installed in buildings.		
305/2011/EU (CPR): EN 12094-1 / EN 54-2 / EN 54-4 ; 2014/30/EU (EMC): EN 50130-4 / EN 61000-6-3 ; 2014/35/EU (LVD): EN 60950-1 ; 2011/65/EU (RoHS): EN 50581		
The declared performance and conformity can be seen in the Declaration of Performance (DoP) and the EU Declaration of Conformity (DoC), which is obtainable via the Customer Support Center: Tel. +49 89 9221-8000 or http://siemens.com/bt/download		
DoP No.: 1116-CPD-018 ; DoC No.: CED-XC1003-A		

09  1116	XC1005-A	Siemens Switzerland Ltd; Gubelstrasse 22 CH-6301 Zug
		Technical data: see doc. 008399
XC1005-A - Electrical extinguishing control device with integrated fire detection and alarm function, incl. FCP1004-E Power supply equipment for use in fire detection and fire alarm systems installed in buildings.		
305/2011/EU (CPR): EN 12094-1 / EN 54-2 / EN 54-4 ; 2014/30/EU (EMC): EN 50130-4 / EN 61000-6-3 ; 2014/35/EU (LVD): EN 60950-1 ; 2011/65/EU (RoHS): EN 50581		
The declared performance and conformity can be seen in the Declaration of Performance (DoP) and the EU Declaration of Conformity (DoC), which is obtainable via the Customer Support Center: Tel. +49 89 9221-8000 or http://siemens.com/bt/download		
DoP No.: 1116-CPD-043 ; DoC No.: CED-XC1005-A		

Issued by
Siemens Switzerland Ltd
Building Technologies Division
International Headquarters
Gubelstrasse 22
CH-6301 Zug
Tel. +41 41 724 24 24
www.siemens.com/buildingtechnologies

© Siemens Switzerland Ltd, 2015
Technical specifications and availability subject to change without notice.